



Alfa Laval – plate technology

It's all about optimizing everything



Alfa Laval's business activities have one sole focus – providing you as the customer with technologies and solutions that help you optimize a wide range of your key industrial processes still further.

Because virtually all forms of industrial processes involve heating or cooling substances of some kind, it is only natural that Alfa Laval focuses strongly on heat transfer technologies and solutions.

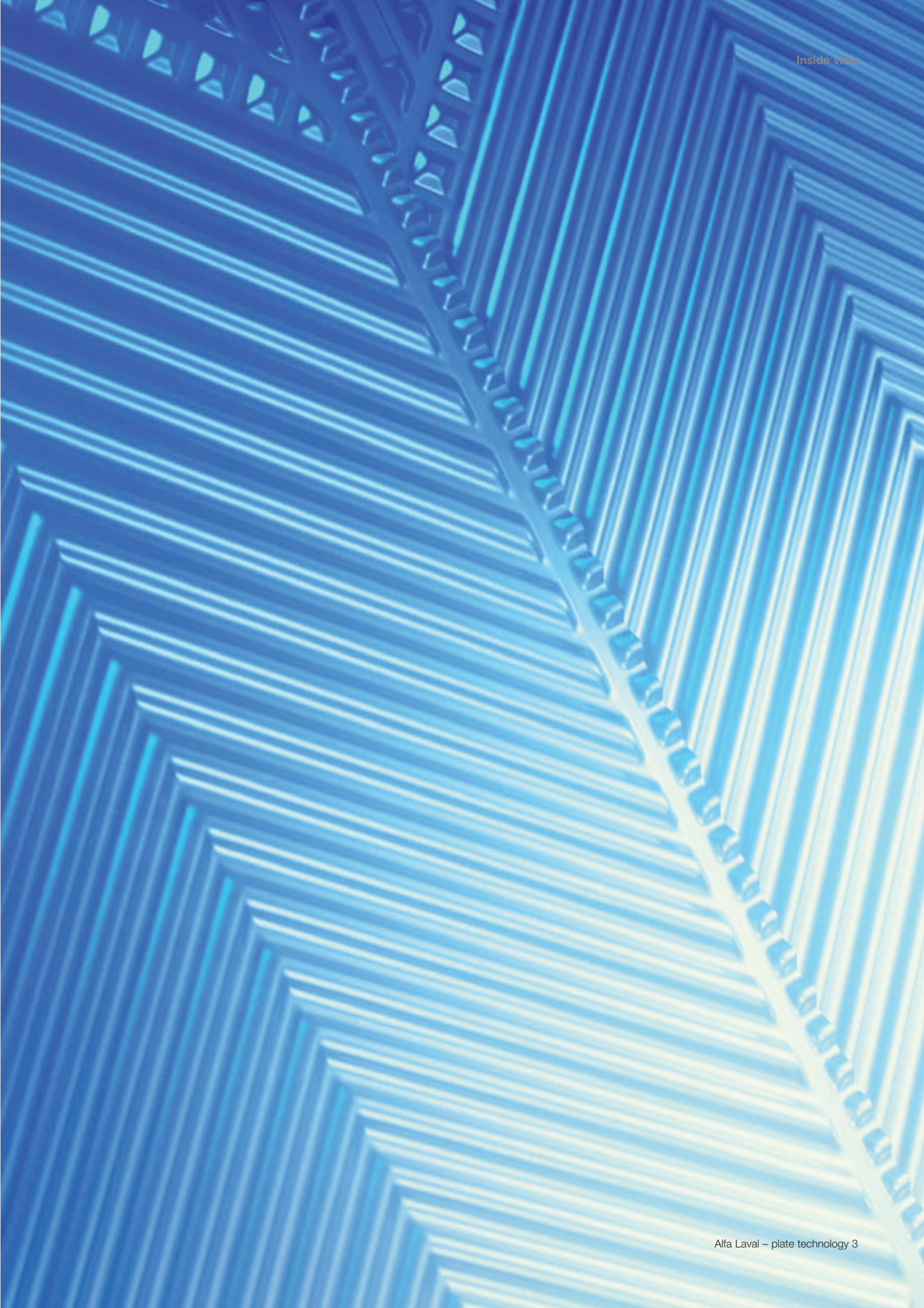

Optimizing the use of heat energy

In any form of heating and cooling, one path to greater profitability is to extract maximum benefit from all the heat energy already available within the system – rather than producing or buying expensive additional heat energy.



Heat transfer involves bringing two substances at different temperatures close to each other, so that one either heats or cools the other. This means that energy already within the system – which is already paid for – is simply transferred to another part of the process where it can be put to greatest effect. This saves you money, saves energy and reduces the overall environmental impact of your production processes.

Only the biggest and best companies in this field have the resources and the know-how to provide a comprehensive range of heat exchanger solutions. Alfa Laval is one of those companies, able to supply the optimal heat transfer technologies to meet your needs.

Heat transfer technologies – the choice

Broadly speaking, shell-and-tube heat exchangers are the large, traditional solution, spiral heat exchangers are the smaller, simple solution and plate heat exchangers are the compact, modern solution with significantly better thermal efficiency and by far the greatest technology development potential.

At Alfa Laval, we want to provide you with optimal solutions. Alfa Laval has therefore focused strongly on plate heat exchanger technology.

Optimizing heat transfer

Plate heat exchangers are designed to optimize heat transfer, because the corrugated plates provide by far the greatest surface area through which the heat can be drawn from one gas or liquid to the other. Despite this substantial area for heat transfer, plate heat exchangers are usually relatively compact. For example, an Alfa Laval Compabloc solution, one of the most compact installations currently available, only takes up about 20% of the physical space needed for a traditional installation.

The design of the channels also ensures maximum turbulence as each fluid passes through. This results in maximum efficiency in transferring heat from one medium to the other.

Distribution area

Located at the top and bottom of the plate, this area is responsible for ensuring fluid is distributed uniformly across the entire width of the plate, eliminating dead spots. This is more complex on modern units where inlet and outlet are aligned vertically for easier piping. Alfa Laval's designs provide complete fluid distribution across even our widest plate.

Plate technology of today

New designs provide improved uniform distribution and higher design pressure capabilities.

Entrance neck

Designed for low pressure drop as well as low velocities for reliable erosion prevention.

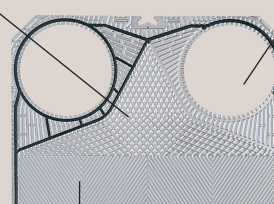

Main heat transfer zone

Critical for creating the highest turbulence consistent with desired pressure drop.



Working principle

The basic plate heat exchanger consists of a series of thin, corrugated plates that are gasketed or welded together (or any combination of these) depending on the liquids passing through and on whether it is practical

to be able to subsequently separate the plates, for whatever reason. The plates are then compressed together in a rigid frame to create an arrangement of parallel flow channels. One fluid travels in the odd numbered channels, the other in the even.

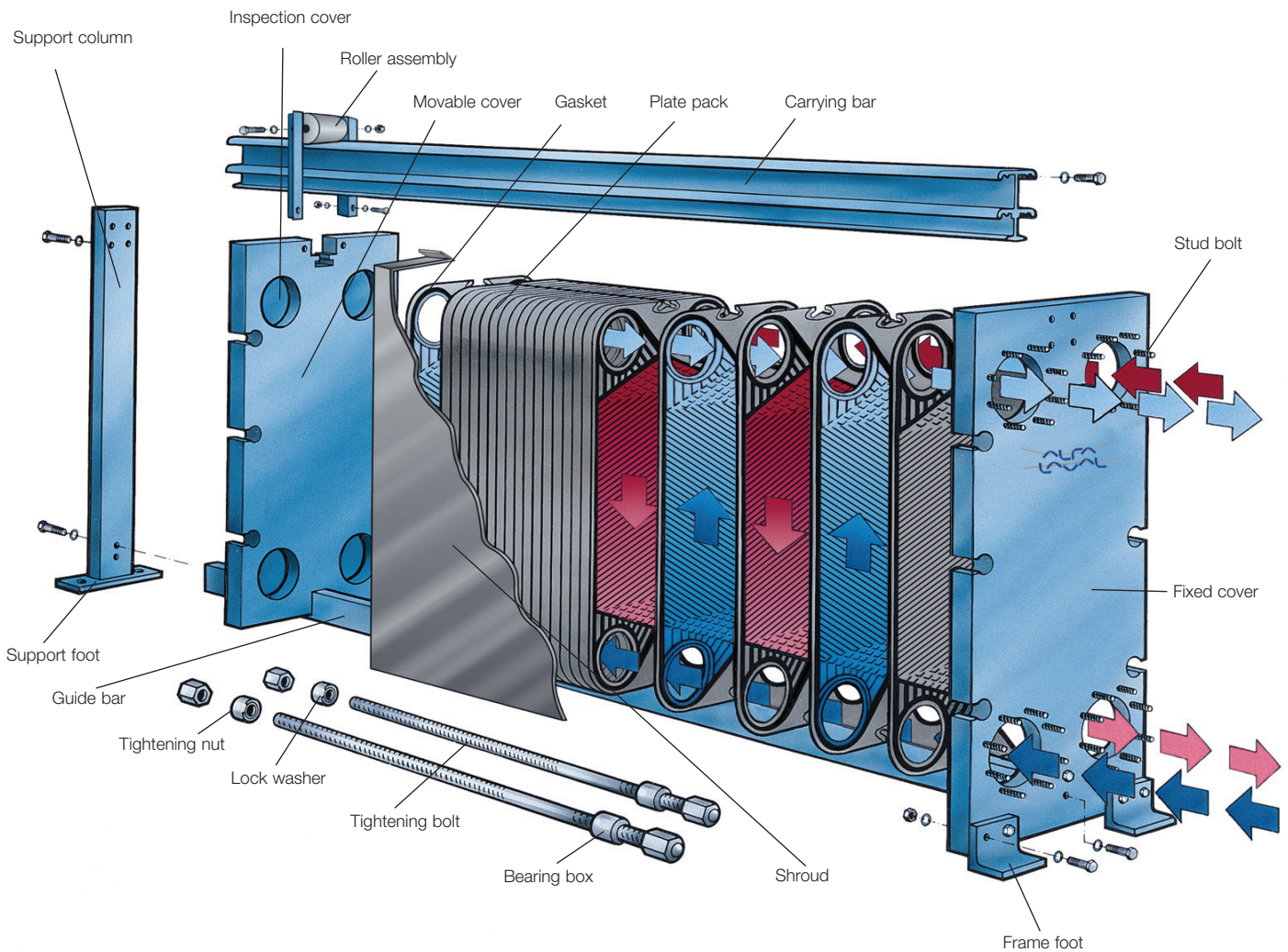

The difference lies on the inside



All plate heat exchangers look similar from the outside. The differences lie inside, in the details of plate design and the sealing technologies used.

Alfa Laval is the largest manufacturer of plate heat exchanger solutions in the world. We use plate heat exchanger design and manufacturing processes that are quite simply in a class of their own:

- single-step pressing of plates – resulting in greater uniformity, less physical stress, thinner plates and more efficient heat transfer
- patented distribution area design – resulting in maximum use of the heat transfer area, the greatest turbulence in the flow, optimum fluid distribution, higher design pressure capabilities and minimal fouling
- the ability to provide you with a complete range of fully optimized plate heat exchanger designs, sizes and applications that can meet virtually any operational specification.

Plate heat exchangers from Alfa Laval are available:

- gasketed or welded together (or any combination of these) using a vast range of carefully researched gasket materials and adhesives.
- as single-phase containing two liquids or for two-phase applications containing a gas and a liquid, and serving as condensers, evaporators and reboilers.
- for a huge range of different temperatures and pressures, and fluids with differing purity, viscosity and solids/fibre content.
- as two-in-one units because the temperature profile and flow through the unit can be managed exactly as required.
- for a vast range of different applications, ranging from the most aggressive and demanding environments, such as the nuclear power industry and offshore oil and gas installations, to the processing of delicate beverages and foodstuffs.

Welded

Completely welded plates expand temperature and pressure limitations to 350°C (650°F) and 40 bar 625 psig.

Glued gaskets

Should your operating condition promote gasket swelling, glued gaskets provide increased reliability, especially for repeated openings. Replacement of glued gaskets is not necessary for servicing. Our oven-cured epoxy affixes the gasket firmly and will not dissolve.

Glue-free gaskets

Glue-free gaskets provide fast and easy gasket replacement on site.

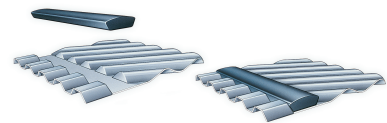
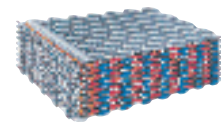

Plate heat exchanger frame

"No Shift" 5-point metal-to-metal alignment system

- Keeps plates aligned easily during opening and closing
- Guarantees first time seal
- Improves reliability against gasket blow-out
- Extends gasket life

SS roller assembly to facilitate opening and avoid wear & tear on carrying bar

Carrying bar

- SS profile to allow easy plate movement

Bolted construction (no welded parts) allowing field assembly and future expansion

5-point guiding system

Connections are available in stainless steel and titanium

Lifting lugs or lifting holes for safe & easy handling

Studded port connection allowing increased pipe loadings

In single-pass units: all connections in frame plate provide maintenance without disconnection of piping

Maximum design pressure up to 30 bar (450 psig). Design temperature up to maximum 180°C (350°F) minimum -50°C (-58°F).

Recess to secure bolts safely

Thicker frame covers with no reinforcements mean fewer tightening bolts and easier opening/closing

In multi-pass units: blind flanges & inspection covers available

Superior bolt closing system

Bolted feet for increased stability and fixing to the floor



Protective shroud meeting OSHA requirement

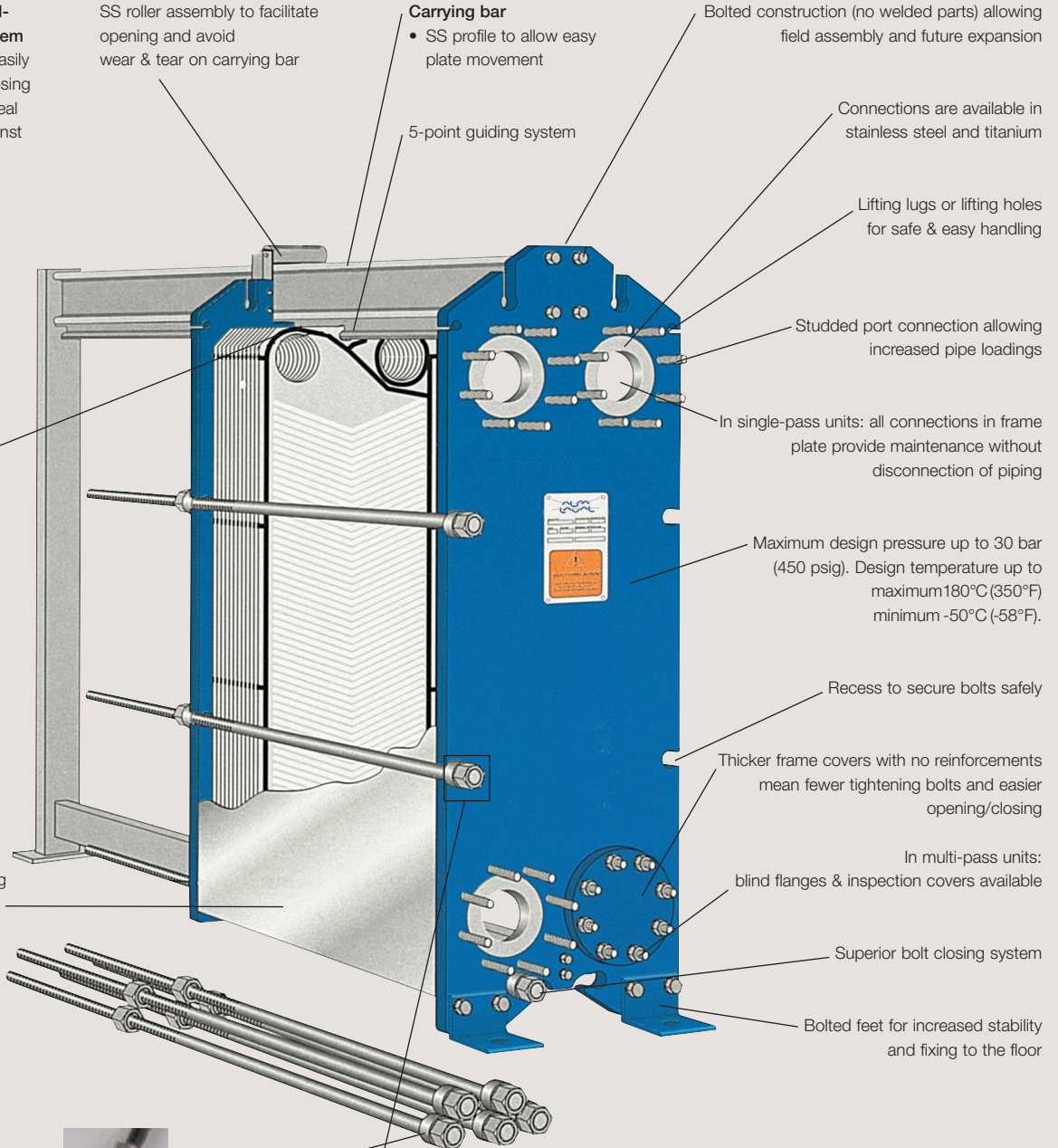

Easy-to-open, easy-to-close tightening system

- Low torque bearing box and lock washers allow easy opening and closing
- Simple, one person operation
- No special tools required
- Rolled threads eliminate galling and seizing
- Bolted construction (no welded parts) allows field assembly and future expansion

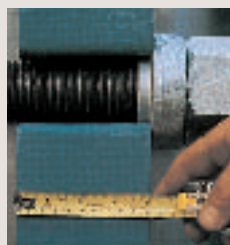

Heavy-duty design without reinforcement

- Applies uniform plate pressure
- Eliminates flexing or bending of plates
- Creates a superior seal
- Extends gasket life

Frame standards

- ASME, "U" and "UM" standard
- PED/CE-mark



Plate innovations

Diabon Graphite® nonmetallic

A composite of fused graphite and fluoroplastic, this unit provides excellent resistance to hydrochloric acid, $AlCl_3$, and other corrosive materials. Unlike traditional graphite, Diabon F® has no porosity or permeability. It resists cracking and breakage during handling and use.

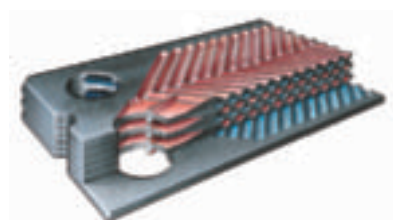

Wide-gap plate

With 12 mm channels free of contact points, this plate is ideal for fluids containing fibres or coarse particles. Each channel has been designed to eliminate bridging of solids in the entrance area.

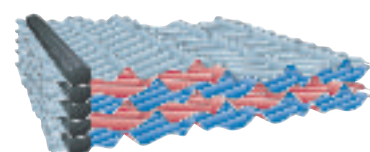

Double-wall plate

Composed of plates pressed simultaneously and laser welded at the port, this is designed for applications where additional reliability against intermixing is necessary to prevent catastrophe. Failure of one plate results in external detection without interleakage. The second wall provides a double barrier between fluids, meeting local health code regulations.

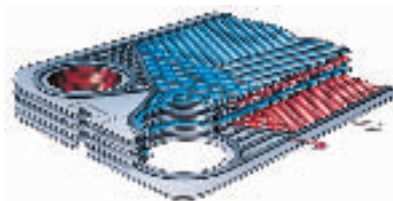

Semi-welded plate

Welded channels for process fluids allow aggressive and difficult fluids to be handled in a plate heat exchanger and expands the pressure range. The gasket exposure is minimal on the welded side.

Welded channel for aggressive fluid

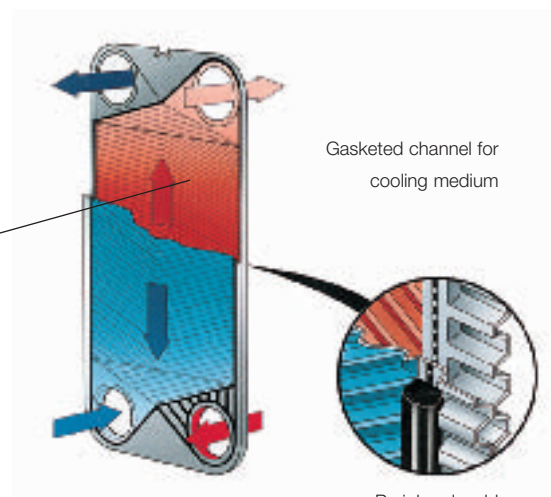

Gasketed channel for cooling medium

Peripheral weld

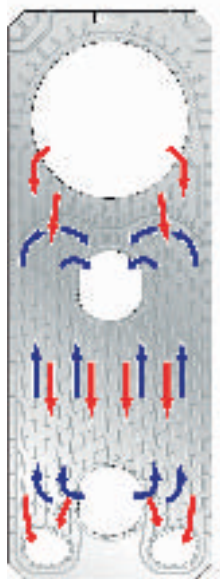
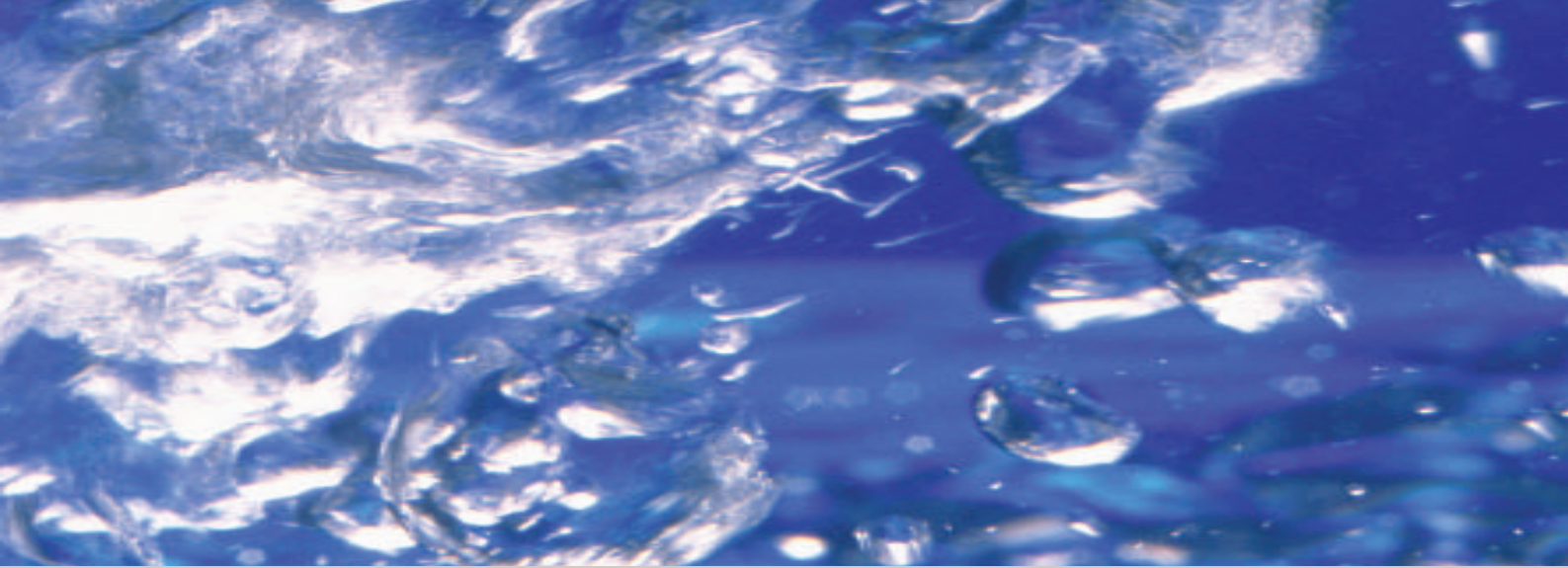

Plate condenser

Compact design plate condenser replaces traditional large units. Customized connections for large volumes of vapour, specific plate pattern, asymmetric plate gap to optimize heat transfer and minimize pressure drop make it suitable for condensation.

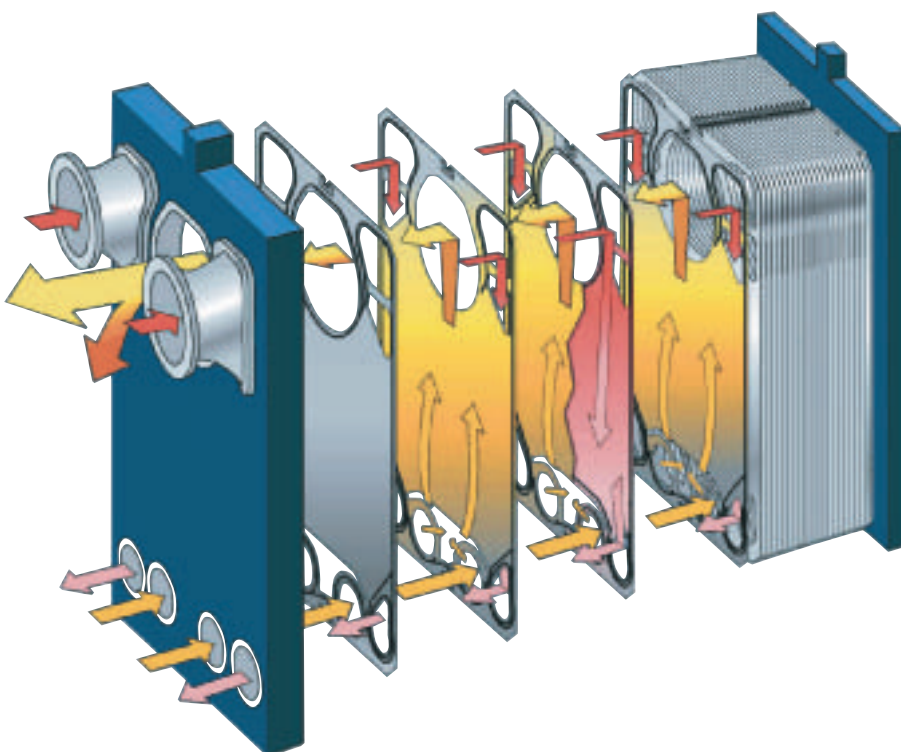

Plate evaporator

Compact and economically efficient, the plate evaporator/condenser replaces conventional large and expensive falling film units. Its deep channels, large ports and laser welding allow vacuum and low pressure evaporation and condensing for both aqueous and organic systems.

The Alfa Laval pay-off

To achieve maximum profitability in modern process industry, it is important that your company can heat and cool a wide range of substances:

- with great precision
- at low overall cost
- with maximum reliability
- with a minimum of energy consumption
- in an environmentally responsible way.

Alfa Laval plate heat exchanger solutions can help you:

Boost performance and capacity

Alfa Laval plate heat exchangers are extremely compact. Due to the very small footprint, often only about 20% of the size of traditional installations, new equipment can be installed even in extremely confined spaces, to boost the performance and capacity of existing plants.

Achieve much greater flexibility and scalability

Alfa Laval plate heat exchangers are all based on a design that is inherently flexible. The number and specifications of the plates can simply be increased, reduced or altered as the capacity you require varies over time. This means less capital tied to application-specific equipment.

Ensure smoother operation

Operations that use Alfa Laval plate heat exchangers are easier to control, and have much lower start-up volume. Because of the vastly greater controlled turbulence in the flow, they are much less affected by troublesome fouling than traditional solutions. They are also subject to less vibration, stress and material fatigue.

Cut down on maintenance, service and cleaning

Alfa Laval plate heat exchangers can make a radical difference to your company's maintenance and service schedules, and the down time these can involve. These solutions feature significantly better flow patterns with much greater turbulence than shell-and-tube heat exchangers.

This gives you much greater heat transfer efficiency with the major added benefit of less fouling and virtually no corrosion or erosion. This results in fewer, much quicker inspections and rapid cleaning. And the Alfa Laval solution means that all cleaning or plate replacement work can be done on site and within the physical footprint of the unit.



Acquire installations that bring you major cost savings

Alfa Laval plate heat exchangers are exceedingly compact in size. In installations that require exotic metals, special alloys and other costly components to deal with aggressive media, this means significant savings in initial purchase costs.

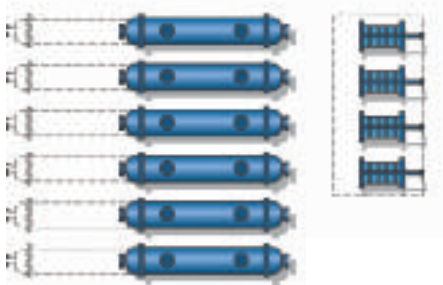

Small size and low weight also mean low initial installation cost, while high heat transfer efficiency means low operating costs throughout the unit's working life. And the major reduction in maintenance requirements compared with traditional equipment also cuts service costs right back.

Ensure minimum environmental impact

Environmental impact is becoming an increasingly critical concern, and Alfa Laval plate heat exchanger solutions provide you with a way of reducing this significantly.

By ensuring maximum heat recovery from any and every one of your industrial processes, as well as the use of less cooling medium and less heating medium, Alfa Laval technology

can give a serious boost to the long-term socio-political acceptability of your industrial operations.

Create a viable technology upgrade path

Shell-and-tube heat exchangers are solutions that do indeed work, but are fundamentally expensive, heavy and essentially obsolescent.

Alfa Laval plate heat exchanger solutions are equally well proven yet they are also light in weight and relatively inexpensive in terms of capital cost, installation cost, operating cost and service cost. And they are capable of virtually unlimited future development as regards the kind of industrial processes you can use them for.

Alfa Laval is able to supply plate heat exchanger that can deal with a continually expanding envelope of pressures and temperatures, as well as liquids with greater viscosity and higher fibre content.

Expanding the envelope

Alfa Laval plate heat exchanger technology also expands the entire envelope of what you can achieve with your company's process technology:

- completely new solutions become possible (combining a condenser and a sub-cooler in one single unit, for example)
- supplementary technologies, such as temperature pinching, can be introduced
- exotic metals can be used at relatively low cost, making it completely feasible to use plate heat exchangers even with volatile and highly corrosive substances

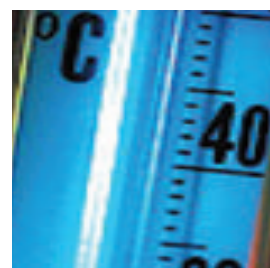

Making the most of it

Competitive advantage and bottom-line profits are always boosted by making the most out of what you've got. But plate heat exchanger solutions from Alfa Laval also make it possible to break new ground. They provide you with ways of significantly boosting:

- the heat transfer capacity at your disposal, at relatively low cost
- your control over the heat transfer process/temperature profile
- your product quality, due to better control of surface heating/cooling, avoiding harmful overheating
- product quantities due to better condensing

Future objectives in plate heat exchanger technology

Alfa Laval is at the forefront of R&D work on plate heat exchangers. Our practical experience indicates that the years to come will feature further development in the following areas:

- energy-saving measures
- units that can work within even greater temperature and pressure ranges
- greater focus on Life Cycle Costs (LCC)
- use in even more industrial applications
- multipurpose installations
- standardized preventative maintenance
- service that can be conducted within the physical footprint of the unit



1 Precision heat transfer

Closer approach temperature
True counter current flow
Capable of handling crossing temperatures
80–90% less hold-up volume

2 Low overall cost

Low capital investment
Reduced installation costs
Limited maintenance expenditure
Minimal operating costs

3 Maximum reliability

Less fouling
Less stress, wear and corrosion
Precision engineering/laser welding

4 Minimum energy consumption

Maximum heat recovery
Lower energy costs
Smaller surface area

5 Environmentally responsible solution

Minimum energy consumption for maximum process effect
Reduced cleaning
Fewer materials used in construction
Lower Life Cycle Costs (LCC)

The full range

One of the key advantages of sourcing your equipment from Alfa Laval is the exceptional range of products and technologies available. Alfa Laval can meet any heat transfer requirement you might have, and all installations are backed by the unparalleled strength of the Alfa Laval Nonstop Performance concept.

This ensures:

- maximum efficiency of all processes
- maximum uptime
- minimum maintenance and service costs.

AlfaRex

Welded plate heat exchanger
Gasket-free, high temperature, high pressure, compact plate heat exchanger.
Laser welded. Two-dimensional welding reduces thermal expansion fatigue.



Brazed units

Using copper or nickel brazing to eliminate gaskets, these compact heat exchangers are perfect for small or packaged applications.



AlfaVap – plate evaporator

Tailored for high-capacity evaporation applications with superior abilities to handle viscous fluids. Features a special plate pattern for stillage evaporation.

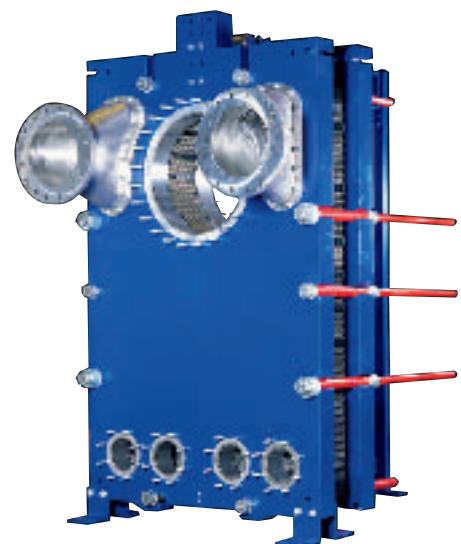



Compabloc®

Welded plate heat exchanger
Versatile as a liquid-to-liquid exchanger, interchanger, reboiler, condenser, evaporator, and steam heater.



Sanitary solutions

Frontline™

Pasteurization and general cooling/heating of dairy, brewery, beverage and viscous products.

Baseline

Cooling and heating of dairy, brewery, beverage and viscous products and pasteurization in some applications.

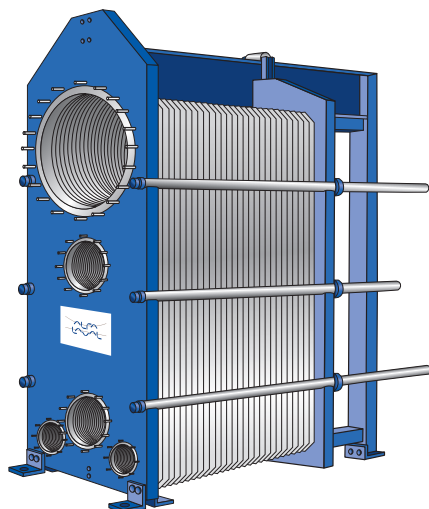

AlfaCond – plate condenser

Compact design plate condenser replaces traditional large units. Customized connections for large volumes of vapour, specific plate pattern, asymmetric plate gap to optimize heat transfer and minimize pressure drop make it suitable for condensation.

Alfa Laval in brief

Alfa Laval is a leading global provider of specialized products and engineering solutions.

Our equipment, systems and services are dedicated to helping customers to optimize the performance of their processes. Time and time again.

We help our customers to heat, cool, separate and transport products such as oil, water, chemicals, beverages, foodstuffs, starch and pharmaceuticals.

Our worldwide organization works closely with customers in almost 100 countries to help them

How to contact Alfa Laval

Contact details for all countries are continually updated on our web site. Please visit www.alfalaval.com to access the information.

